

**DynaVision'**  
**M-SERIES M24 SENSOR**  
**OEM DOCUMENTATION**  
**MODEL M24 -14 - 24**

by

**Dynamic Control Systems Inc.**



**finger GmbH & CO KG**  
**Sapelloh 84**  
**31606 Warmsen**  
**Tel.: +49 (0) 5767 9602 0**  
**Fax. +49 (0) 5767 93004**  
**email: [info@finger-kg.de](mailto:info@finger-kg.de)**  
**[www.finger-kg.de](http://www.finger-kg.de)**

January 1996  
Version1.0

**DYNAMIC  
CONTROL  
SYSTEMS INC.**

**DYNAVISION'  
PRODUCTS**

---

**GUIDE TO  
OPERATIONS**

**DYNAVISION™  
M-SERIES M24 SENSOR  
OEM DOCUMENTATION**

## **PROPRIETARY**

**THIS DOCUMENT, SUBMITTED IN CONFIDENCE, CONTAINS PROPRIETARY INFORMATION WHICH SHALL NOT BE REPRODUCED OR TRANSFERRED TO OTHER DOCUMENTS OR DISCLOSED TO OTHERS OR USED FOR MANUFACTURING OR ANY OTHER PURPOSE WITHOUT PRIOR WRITTEN PERMISSION OF DYNAMIC CONTROL SYSTEMS INC.**

# M-SERIES OEM DOCUMENTATION

---

<b>1. OVERVIEW</b>	<b>4</b>
<b>2. FUNCTIONAL DESCRIPTION</b>	<b>6</b>
<b>2.1 M24 SENSOR HEAD</b>	<b>6</b>
<b>2.2 M24MX4 (MULTIPLEX) BOARD</b>	<b>6</b>
<b>2.3 M24COM (COMMUNICATION) BOARD</b>	<b>6</b>
<b>2.4 M24HST (HOST) BOARD</b>	<b>7</b>
<b>2.5 M24C10 SYSTEM ENCLOSURE</b>	<b>7</b>
<b>2.6 SCAN RATE</b>	<b>7</b>
<b>2.7 MEASUREMENT RANGE</b>	<b>7</b>
<b>2.8 MEASUREMENT RESOLUTION</b>	<b>7</b>
<b>2.9 ELECTRICAL POWER REQUIREMENTS</b>	<b>7</b>
<b>3. SAFETY REQUIREMENTS</b>	<b>8</b>
<b>3.1 DYNAVISION SENSOR HEAD</b>	<b>8</b>
<b>3.2 LASER SAFETY REQUIREMENTS</b>	<b>9</b>
3.2.1 OEM SAFETY RESPONSIBILITIES	11
<b>3.3 ELECTRONICS HANDLING PROCEDURES</b>	<b>12</b>
<b>3.4 WELDING AND THE SCANNER FRAME</b>	<b>12</b>
<b>4. SCANNER HARDWARE</b>	<b>13</b>
<b>4.1 SCANNER CABINET</b>	<b>13</b>
4.1.1 M24MX4 BOARD	14
4.1.2 M24COM BOARD	17
<b>4.2 M24 SENSOR HEADS</b>	<b>20</b>
4.2.1 CABLING/POWER	20
<b>5. SCANNER SOFTWARE</b>	<b>21</b>
<b>5.1 WHAT'S ON THE DISK?</b>	<b>21</b>
<b>5.2 BIOS CONSIDERATIONS</b>	<b>21</b>
<b>5.3 PROGRAMMING APPLICATION EXAMPLE - BOARD SCANNING</b>	<b>22</b>
5.3.1 OVERVIEW	22
5.3.2 PSEUDO CODE	22
<b>5.4 DIAGNOSTICS</b>	<b>22</b>
<b>5.5 CALIBRATION</b>	<b>23</b>
5.5.1 LASER ALIGNMENT OFFSET	23
5.5.2 RANGE OFFSET	24
<b>5.6 M24-SERIES C LIBRARY</b>	<b>25</b>
5.6.1 OVERVIEW	25
5.6.2 'C ' INTERFACE	25

---

<b>5.7 M24 DIAGNOSTIC PROGRAM</b>	<b>31</b>
5.7.1 OVERVIEW	31
5.7.2 SYSTEM SCREEN	31
5.7.3 3D PROFILE SCREEN	33
5.7.4 DIAGNOSTIC SCREEN	34
5.7.5 BAR GRAPH SCREEN	34
5.7.6 STATUS SCREEN	35
5.7.7 TIMING SCREEN	38
<b>6. OPTIMIZATION IMPLEMENTATION</b>	<b>40</b>
<hr/>	
<b>6.1 RESIDENT OPTIMIZER ('386/'486/PENTIUM CPU)</b>	<b>40</b>
<b>6.2 RESIDENT CO-PROCESSOR OPTIMIZER</b>	<b>40</b>
6.2.1 NON-INTEL BASED SYSTEMS	40
<b>7. SCANNER FRAME DESIGN</b>	<b>41</b>
<hr/>	
<b>7.1 OVERVIEW</b>	<b>41</b>
<b>7.2 CHAIN SPACING</b>	<b>42</b>
7.2.1 NEW MECHANICAL	42
7.2.2 RETRO-FIT MECHANICAL	42
<b>7.3 FRAME DRAWINGS</b>	<b>42</b>
<b>8. SCANNER INSTALLATION</b>	<b>47</b>
<hr/>	
<b>8.1 FRAME CONSIDERATIONS</b>	<b>47</b>
<b>8.2 POWER SUPPLY CABINET CONSIDERATIONS</b>	<b>47</b>
<b>8.3 INSTALL POWER CABLING</b>	<b>47</b>
8.3.1 IDENTIFY THE POWER CABLE WIRING	48
8.3.2 IDENTIFY THE TERMINAL BLOCKS	48
8.3.3 CONNECT THE DC POWER WIRING	48
8.3.4 CONNECTING AC POWER	48
<b>8.4 INSTALLING SCAN HEADS</b>	<b>49</b>
<b>8.5 INSTALL COMPUTER CABINET</b>	<b>51</b>
<b>8.6 INSTALLING TWIN-AXIAL CABLES</b>	<b>51</b>
<b>8.7 INSTALLING THE ENCODER</b>	<b>51</b>
<b>8.8 M24 SENSOR HEAD CHECKOUT</b>	<b>51</b>
8.8.1 SETTING UP BAFFLE PLATES	51
8.8.2 CHECKING SCANNER READINGS	52
<b>8.9 ENCODER CHECKOUT</b>	<b>52</b>

## **1. OVERVIEW**

The DynaVision™ M24 optical scanner by Dynamic Control Systems Inc. (DCS) is a general purpose lumber profile scanner capable of supplying a 3 dimensional profile for lumber recovery optimization.

The DynaVision™ M24 scanner can be interfaced to many hardware platforms (ISA bus, VME, VAX, etc.) through the industry standard IndustryPack® interface. IndustryPack carriers are supported by several 3rd party vendors for different computer platforms.

### **We deliver the following components:**

- M24 sensor heads                      laser distance sensors
- M24MX4 boards                        interface boards which collect data from up to four M24 sensor heads
- M24COM board                        communication board which transfers data via fiber optic links to the M24HST board and interfaces to an encoder.
- M24HST board                        IndustryPack module which gets connected to an IndustryPack carrier and receives data via fiber optic links from the M24COM board.
- ATC30 board                         IndustryPack carrier from GreenSpring Computers Inc. for PC/AT platforms which gets installed in 486 or Pentium® based systems.
- M24C10 system enclosure            10 slot system enclosure from Diversified Technology Inc. to host the M24MX4 and M24COM boards.
- Fiber-optic cable                     Pre-made fiber-optic cable complete with connectors to transfer data from the M24COM board to the M24HST board.
- M24 library                         Software interface library to provide access to the scanner data.
- M24 program                         Software to support the installation of the M24 system.

### You also need:

- Scanner frame                      A scanner frame to mount the M24 sensor heads. Guidelines to the design of the scanner frame are outlined in chapter 7.
- Power supply                        Power supply to provide +15 VDC to the M24 sensor heads.
- Power supply cabinet              Cabinet to host the +15 VDC power supply and the M24C10 system enclosure.
- Twin-Axial cable                    Shielded cable to transfer data from the M24 sensor heads to the M24MX4 boards.
- BNC connectors                     Connectors to interface the twin-axial cable to the M24 sensor heads and M24MX4 boards.
- Rotary encoder                      A encoder coupled mechanically to the chain to produce pulses in proportion to the chain travel.
- Host computer                        Computer to run any software using the M24 scanner 3D data.
- UPS                                    Uninterruptible power supply to provide 120 VAC to the host computer and the power supply cabinet.
- Calibration bar                      A square profile bar to calibrate the M24 system.

## **2. FUNCTIONAL DESCRIPTION**

The M24 scanner system is built up in 2 foot (600 mm) sections, the length of each M24 sensor head. Each sensor head projects twenty-three (23) laser beams on the target surface at 1" (25.4mm) spacing. The sensor heads may be mounted above and below the target (Top/Bottom scanning) or above the target (Top only scanning). Top/Bottom scanning allows true thickness measurements at each laser beam. Top only scanning provides thickness profiles at each laser beam relative to a fixed reference point. The M24MX4 collects measurements from these heads and stores them for use by the host computers for optimization. The use of several heads and M24MX4 boards allows for scanners up to 32 feet (9.8 m).

### **2.1 M24 SENSOR HEAD**

Each head projects twenty-three (23) laser beams onto a target surface at 1" (25.4mm) spacing. Each laser spot is detected by a CCD line camera and the target range is calculated using the triangulation method. There are two connectors, a military type connector for the +15 VDC power and RS-485 communication to the head and a BNC connector for transmitting real-time data to the M24MX4 board using high speed TAXI communication hardware. Use of serial RS-485 communication vs. TAXI communication is application dependent (sampling rate requirements, number of sensors in the system etc.).

The M24 scanner head uses only solid state components including solid lasers. Reliability is improved by avoiding the use of beam splitters, spinning mirrors or other mechanical devices. All components are mounted in a solid aluminum CNC machined package which can be installed directly in the sawmill environment.

### **2.2 M24MX4 (MULTIPLEX) BOARD**

The M24MX4 board interfaces to and collects complete 3D profiles for up to 4 sensor heads. This would typically represent a 4 foot section consisting of 2 sets of top / bottom heads. Each controller board provides 30 MIPs (million instructions per second) of processing capacity. Each M24 sensor head is connected to the board through a twin-axial cable, for a total of 4 cables into the card.

The M24MX4 boards are mounted into the M24C10 system enclosure located at the scanner frame. A maximum of 8 of these cards can be inserted into the M24C10 enclosure. The M24MX4 boards communicate to the M24COM board through the M24C10 backplane.

### **2.3 M24COM (COMMUNICATION) BOARD**

The M24COM board provides the interface between the scanner frame and the host computer. There is one M24COM board per system. The principal function is to process commands received from the host computer (application software) and collect range data from each of the M24MX4 boards plugged into the M24C10 backplane and transmit them back to the host computer. A bi-directional encoder that is driven from the transfer chain through the scanner is interfaced to the M24COM board through a DB9 connector. The encoder signals are distributed internally to each of the M24MX4 boards. For each encoder pulse, a profile of range readings is stored.

The card transmits data to the host computer via 2 'fiber-optic' cables. The advantage of the fiber-optic cable is the high data transfer capacity and the electrical insulation between the scanner frame and the host computer. The fiber-optic cables are pre-made complete with connectors in 150 foot (50 m) and 300 foot (100 m) lengths.

### 2.4 M24HST (HOST) BOARD

The M24HST board resides in the host computer backplane and provides a high speed TAXI fiber-optic communication interface with the M24COM board at the scanner frame. There is one M24HST board per system.

The M24HST board is an IndustryPack (IP) module plug and electrically compatible with standard IP carrier boards provided for many different platforms e.g. ISA, VME or VAX. The M24HST board contains the fiber-optic connectors and the specific circuitry to interface to the M24COM board at the scanner frame. For example, if the M24 scanner was to be changed from an VME host computer platform to an ISA host computer platform, the IP carrier board would change to match the platform but the IP module (M24HST) and the M24 scanner would remain the same.

### 2.5 M24C10 SYSTEM ENCLOSURE

The M24C10 cabinet provides a common platform to plug the M24MX4 and MX24COM boards into for communications and power distribution. The M24C10 is a self contained unit consisting of a 10 slot ISA passive backplane, power supplies and card cage. The system enclosure must be mounted inside an industrial NEMA enclosure at the scanner frame to protect the electronics and is mounted on the back panel of that enclosure.

### 2.6 SCAN RATE

The M24 sensor head is capable of measurement samples being taken approximately 1000 times per second. When an encoder is connected to the M24COM board one measurement is stored for each pulse generated by the encoder. The encoder is driven by the transfer chain (belt) which moves material through the scanner. While the M24COM board may be capable of servicing encoder generated interrupts at frequencies greater than 1 kHz, the data returned would be contain duplicate scans, therefore the maximum encoder rate should not exceed 1000 pulses per second.

### 2.7 MEASUREMENT RANGE

Each sensor head has a 24" range from 14"- 38" from the front surface of the head.

### 2.8 MEASUREMENT RESOLUTION

Thickness	-	$\pm 0.010''$
Width	-	$\pm 1$ encoder pulse
Length	-	$\pm 1''$

### 2.9 ELECTRICAL POWER REQUIREMENTS

M24 sensor heads	-	+14.5 .. +15.5 VDC / 1.5 Amp
M24C10 enclosure	-	120 VAC / 4.0 Amp

## 3. SAFETY REQUIREMENTS

The DynaVision sensor head uses lasers for measuring ranges. This requires that specific safety precautions are taken when interacting with the M24 scanner system.

**Caution!** Use of controls or adjustments, or performance of procedures other than those specified herein may result in hazardous radiation exposure.

Additional precautions need to be taken when handling sensitive electronic components to ensure the long life and reliability of these parts.

### 3.1 DYNAVISON SENSOR HEAD

The lasers used in the DynaVision sensor heads are near infrared (Class IIIB) units. These operate just outside the visible range of the eye (780nm) and are only visible in a darkened room. Even so, the laser's intensity is high enough to damage the eyes if viewed directly.

Each DynaVision sensor head uses 23 low power near infrared lasers to measure a two (2) foot section of material. The laser light is emitted from the 23 round windows on each sensor head. During normal operation, the lasers do not pose any hazard to the mill personnel. The only situation in which the lasers could be viewed directly would be when personnel are working inside the throat of the scanner frame with the lasers on.

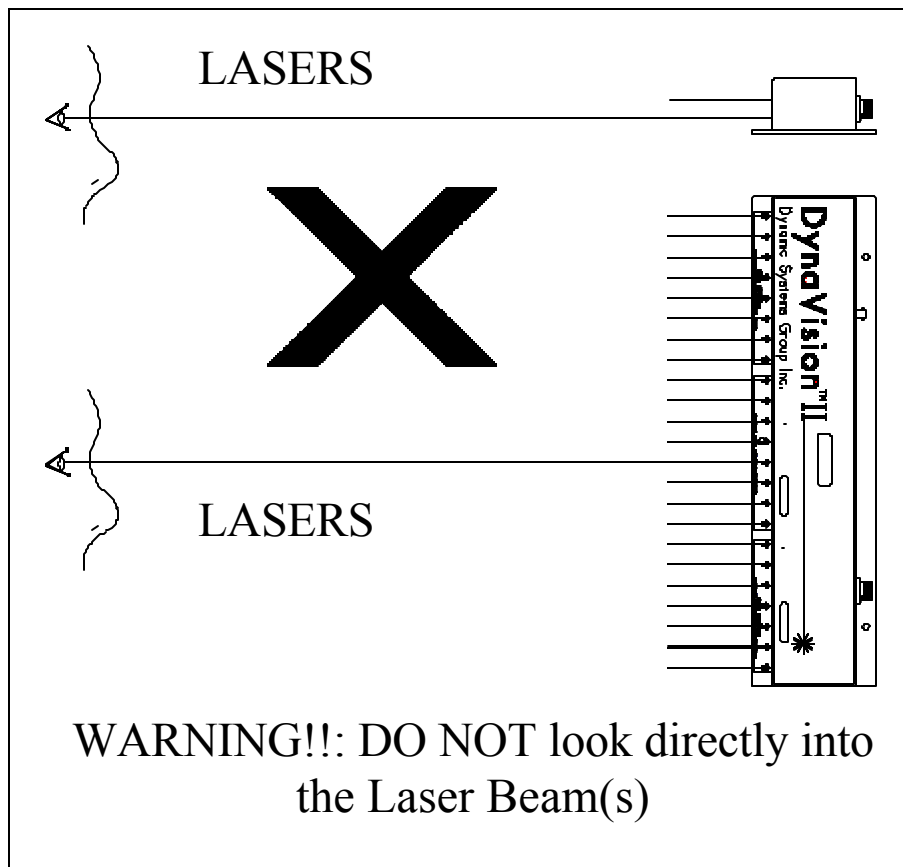

## 3.2 LASER SAFETY REQUIREMENTS

For systems which will be sold or used in the United States, the Department of Health and Human Services specify that a number of laser safety requirements be maintained. Full details of these requirements are specified in the booklet "Regulations for the Administration and Enforcement of the Radiation Control for Health and Safety Act of 1968": HHS Publication FDA 88-8035. This publication can be obtained directly from the FDA. Dynamic Control Systems Inc. has filed a report with the FDA to assist OEM's in achieving certification of their own applications. These reports can be referenced by their accession number which will be provided upon request.

It is recommend that the information packet be obtained from the FDA for full details on what the OEM requires to meet FDA certification. With reference to the FDA specifications, the following items should be noted:

- 1) In accordance with the HHS standards under the Radiation Control for Health and Safety Act of 1968, the following safety labels are affixed to each individual sensor head:



**Warning Label**

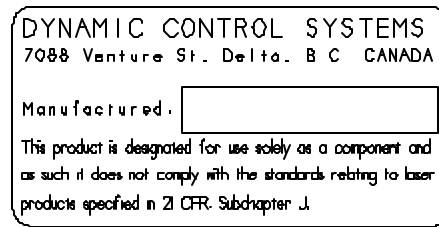

**Manufacturer ID /  
Certification Label**

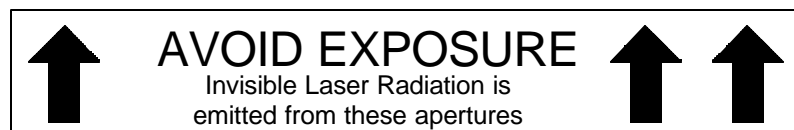

**Aperture Label**

Warning labels should also be attached to the scan frame where they are clearly visible.



### **3.2.1 OEM Safety Responsibilities**

Dynamic Control Systems Inc. has filed a report with the FDA to assist OEM's in achieving certification of their own applications by referencing the report accession number. However, the following paragraphs outline areas which are not covered by Dynamic Control Systems Inc. submission and need to be addressed by the OEM.

#### **3.2.1.1 Scanner Frame Laser Warning Signs**

Laser warning signs must be located in the vicinity of the scanner frame such that they will be readily observed. Refer to the following diagram for an example of the laser warning sign.



#### **3.2.1.2 Laser Emission Warning Indicators**

As specified by the U.S. Department of Health and Human Services under the Radiation Control for Health and Safety Act of 1968, it is required that the controls which operate the scanners incorporate a visible or audible signal when the lasers of the sensors are active.

Typically this consists of a warning lamp on top of the power supply cabinet which is illuminated when power is supplied to the scan frame. The DynaVision sensor heads also incorporate indicators which illuminate when power is applied to the sensors and the lasers are operating. However, if the distance between the scanner frame and the power supply cabinet exceeds 2 meters, a second power-on indicator should be mounted on the scanner frame. When mounting the warning indicator it is important not to mount it in a location which would require human exposure to the laser emissions.

Additionally, CDRH standards require that the indicator be clearly visible through protective eyewear designed specifically for the wavelengths of the emitted laser radiation.

#### **3.2.1.3 Beam Attenuators**

CDRH standards also specify that a permanently attached method of preventing human access to the laser radiation other than switches, power connectors, or key control must be employed.

### **3.2.1.4 Power-On Delays**

For Class IIIB laser systems, a delay circuit is required which illuminates the warning indicators on the cabinet and frame for a short period of time (approximately 20 seconds) prior to supplying power to the lasers themselves.

### **3.2.1.5 Keylock Switch**

For Class IIIB laser systems the power supply cabinets must have a keylock switch which when in the OFF position prevents any power from being supplied to the lasers. Additionally, the switch must not allow the key to be removed from the lock while in the ON position.

### **3.2.1.6 Remote Interlock Connector**

A remote interlock connection must be present in all Class IIIB laser systems. This permits remote switches to be attached in serial with the keylock switch on the controls. The deactivation of any remote switches must prevent power from being supplied to the lasers.

## **3.3 ELECTRONICS HANDLING PROCEDURES**

The DynaVision M24 optical scanner consists of several electronic components that can be easily damaged by electrostatic discharge (ESD). ESD damage normally occurs as a result of handling electronic circuit boards and components without 'grounding' the body. 'Grounding' the body of the person handling the components discharges any static to ground instead of through the components themselves.

The DynaVision optical scanner consists of several printed circuit boards and components that could be damaged without the following handling precautions:

- 1) Always ground your body using a wrist strap in contact with bare skin attached to a solid ground such as a chassis etc. Do not handle any components unless grounded first.
- 2) Printed circuit boards are usually stored and shipped in plastic conductive bags. The boards should only be removed from or placed in these bags when your body is completely grounded. Make sure spare boards are always replaced in these bags before storage.
- 3) Only after completing service replacement should the ground strap be removed.

## **3.4 WELDING AND THE SCANNER FRAME**

DynaVision scanners are optical apparatus, and care must be taken to ensure that nothing affects their optical performance.

The camera used inside each M24 sensor head can be damaged by very intense light. Additionally, the debris generated while welding is normally hot enough to mar or imbed itself in the surface of the glass lenses covering the lasers and camera. Therefore, it is recommended that the sensor heads are shielded before any welding takes place in close proximity of the scanner frame.

**4. SCANNER HARDWARE**

**4.1 SCANNER CABINET**

The M24MX4 and M24COM boards are plugged into the M24C10 10-slot system enclosure supplied with the scanner system. One M24MX4 board is installed in the M24C10 cabinet for every four M24 sensor heads. The left most board is for the 1st four sensor heads located starting at the zero lumber line (0') end of the scan frame. The following board placement is recommended to make cabling and interfacing standard for all lengths of scanners.

**IMPORTANT!**  
The power must NOT be applied to the M24C10 cabinet when installing or removing any cards.

Top View

Slot #	1	2	3	4	5	6	7	8	9	10
L E F T	<b>M</b>	<b>M</b>	<b>M</b>	<b>M</b>	<b>M</b>	<b>M</b>	<b>M</b>	<b>M</b>	<b>M</b>	R I G H T
	<b>2</b>	<b>2</b>	<b>2</b>	<b>2</b>	<b>2</b>	<b>2</b>	<b>2</b>	<b>2</b>	<b>2</b>	
	<b>4</b>	<b>4</b>	<b>4</b>	<b>4</b>	<b>4</b>	<b>4</b>	<b>4</b>	<b>4</b>	<b>4</b>	
	<b>C</b>	<b>M</b>	<b>M</b>	<b>M</b>	<b>M</b>	<b>M</b>	<b>M</b>	<b>M</b>	<b>M</b>	
	<b>O</b>	<b>X</b>	<b>X</b>	<b>X</b>	<b>X</b>	<b>X</b>	<b>X</b>	<b>X</b>	<b>X</b>	
	<b>M</b>	<b>4</b>	<b>4</b>	<b>4</b>	<b>4</b>	<b>4</b>	<b>4</b>	<b>4</b>	<b>4</b>	
	<b>H</b>	Card	Card	Card	Card	Card	Card	Card	Card	
	<b>O</b>	0	1	2	3	4	5	6	7	
	<b>S</b>	Heads	Heads	Heads	Heads	Heads	Heads	Heads	Heads	
	<b>T</b>	0 - 3	4 - 7	8 - 11	12 - 15	16 - 19	20 - 23	24 - 27	28 - 31	
<b>C</b>	C O M M U N I C A T I O N	<b>M</b>	<b>M</b>	<b>M</b>	<b>M</b>	<b>M</b>	<b>M</b>	<b>M</b>	<b>M</b>	
<b>O</b>		u	u	u	u	u	u	u	u	
<b>M</b>		l	l	l	l	l	l	l	l	
<b>C</b>		t	t	t	t	t	t	t	t	
<b>O</b>		p	p	p	p	p	p	p	p	
<b>M</b>		l	l	l	l	l	l	l	l	
<b>C</b>		e	e	e	e	e	e	e	e	
<b>O</b>		x	x	x	x	x	x	x	x	
<b>M</b>										
<b>S</b>										
<b>T</b>										
Installed	*	*								

\* = Always Installed

**4.1.1 M24MX4 Board**

The M24MX4 board interfaces to and collects complete 3D profiles for up to four M24 sensor heads. This would typically represent a 4 foot section consisting of 2 sets of top / bottom heads. Each M24MX4 board provides 30 MIPS (million instructions per second) of processing capacity. Each sensor head is connected to the board through a ‘twin-ax’ cable, for a total of 4 cables into the board.

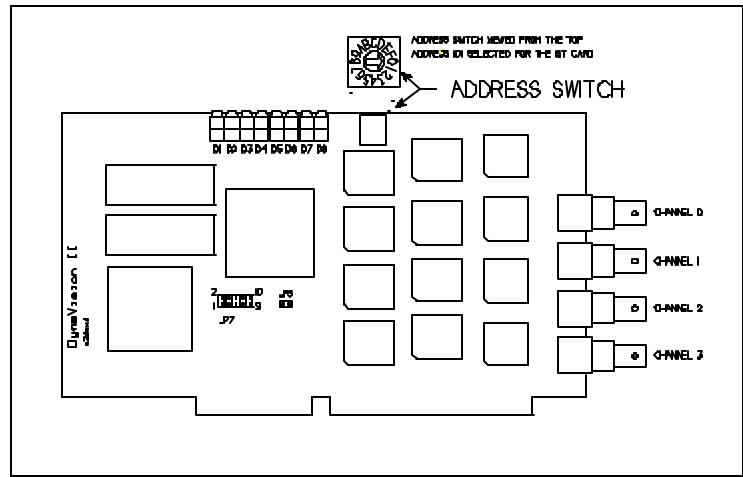

M24MX4 Circuit Board

**4.1.1.1 Addressing**

Board addressing is set from 0 to 7 using a rotary switch located on the board and has always to start with address 0. If the addressing is set the same for two or more of the M24MX4 boards plugged into the M24C10 backplane there will be an address conflict resulting in no or incorrect data being read from the sensors.

The setting of the rotary switch is according to the following table:

Switch	Card	Top / Bottom Scanning		Top Only Scanning	
		Heads	Nominal Location	Heads	Nominal Location
0	0	0..3	0-2' & 2-4' Top / Bottom	0..3	0-2', 2-4', 4-6', 6-8' Top
1	1	4..7	4-8' & 6-8' Top / Bottom	4..7	8-10', 10-12', 12-14', 14-16' Top
2	2	8..11	8-10' & 10-12' Top / Bottom	8..11	16-18', 18-20', 20-22', 22-24' Top
3	3	12..15	12-14' & 14-16' Top / Bottom	12..15	24-26', 26-28', 28-30', 30-32' Top
4	4	16..19	16-18' & 18-20' Top / Bottom		
5	5	20..23	20-22' & 22-24' Top / Bottom		
6	6	24..27	24-26' & 26-28' Top / Bottom		
7	7	28..31	28-30' & 30-32' Top / Bottom		
8..A	<b>Reserved</b>				

**4.1.1.2 L.E.D. Indicators**

The top edge of the circuit board contains 8 L.E.D. indicators visible when the board is plugged into the M24C10 backplane.

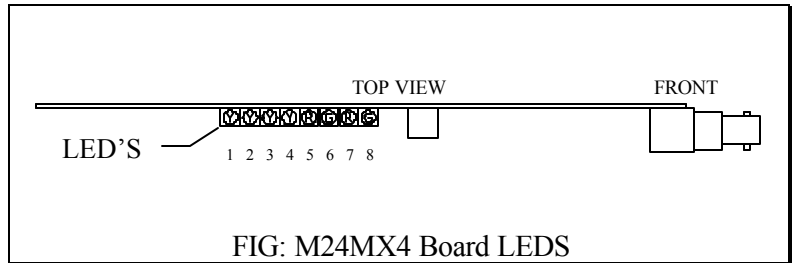

The LED's are assigned as follows:

L.E.D.	Colour	Function
D1	YELLOW	This three LED's code the M24MX4 scan status. They can be considered as bits 0, 1 and 2 of the following scan status code: 5 - end of scan, 6 - scanning, 7 - ready to scan
D2	YELLOW	
D3	YELLOW	
D4	YELLOW	RUN light: Flashes when the CPU is running.
D5	RED	Encoder Reverse: Flashes when the encoder is rotating reverse
D6	GREEN	Encoder Forward: Flashes when the encoder is rotating forward
D7	RED	RECEIVE data from M24COM board over the M24C10 backplane
D8	GREEN	TRANSMIT data to M24COM board over the M24C10 backplane

**4.1.1.3 On Board Headers**

There are two headers labelled JP5 and JP7 located on the circuit board.. Both JP5 and JP7 are for **factory testing only** and there setting should not be changed. JP5 must have a jumper on it at all times during operation, JP7 doesn't have any jumper set.

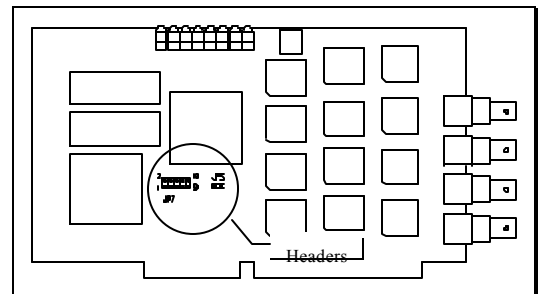

**4.1.1.4 Connecting the M24MX4 to the Sensor Heads**

Standard 78 ohm twin-ax cable is used to transmit the clock and video signals from each M24 sensor head. There is one twin-ax cable for each sensor heads connected to the M24MX4 board. It is recommended to use the following cables and connectors:

Item	Manufacturer / Model #
Twin-Axial Cable end connectors	Amphenol 31-224
Twin Axial (78 ) cable	Belden G9463 Blue Hose™

The following diagrams shows the cabling connections for top/bottom and a top only scanner configuration. Twin axial cable lengths should be as short as possible and less than 50 feet. It is recommended that the twin-ax cables are run through the scanner frame to each head. Take care to ensure that the cables do not get ‘nicked’ or ‘kinked’.

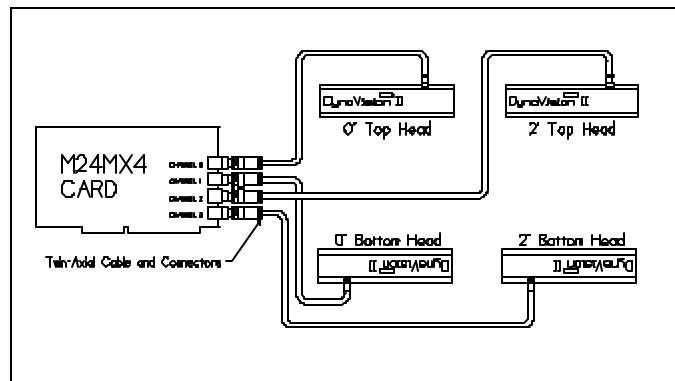

Fig: Top / Bottom Scanning

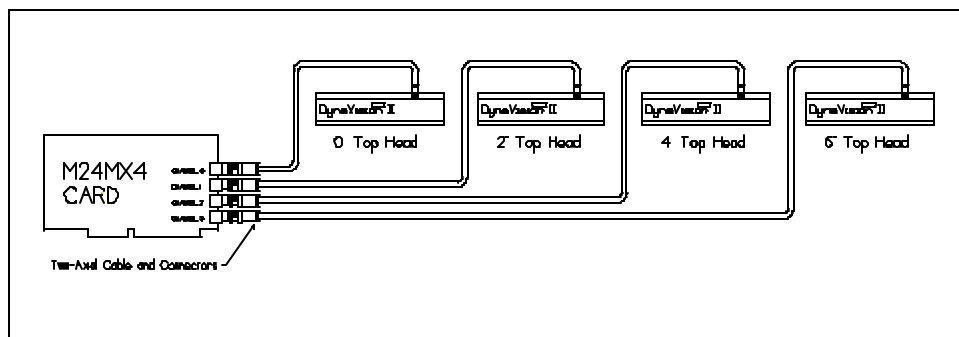

Fig: Top Only Scanning

**4.1.2 M24COM Board**

The M24COM board interfaces the scanner frame and the host computer. There is one M24COM board per system. The principal function is to process commands send from the host and collect profiles from each of the M24MX4 boards plugged into the M24C10 backplane and transmit them back to the host computer. A bi-directional encoder that is driven by the transfer chain through the scanner is connected to the M24COM board through a DB9 connector. The encoder signal is distributed internally to each of the M24MX4 boards. For each encoder pulse, a profile of range readings are stored.

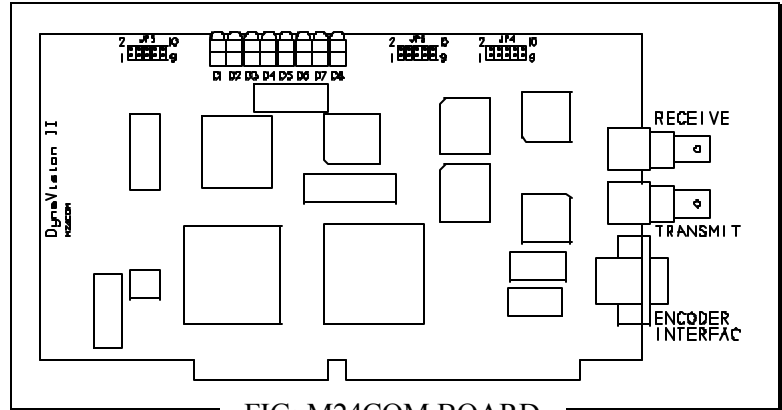

FIG: M24COM BOARD

The card is connected to the host computer with 2 fiber-optic cables. The advantage of the fiber-optic cable is the high data transfer capacity and the electrical insulation between the scanner frame and the host computer. The fiber-optic cables are pre-made complete with connectors in 150 foot (50 M) and 100 foot (100 M) lengths.

**4.1.2.1 Addressing**

There is no address required for the M24COM board.

**4.1.2.2 L.E.D. Indicators**

The top edge of the circuit board contains 8 L.E.D. indicators visible when the board is plugged into the M24C10 backplane. The LED's are assigned as follows:

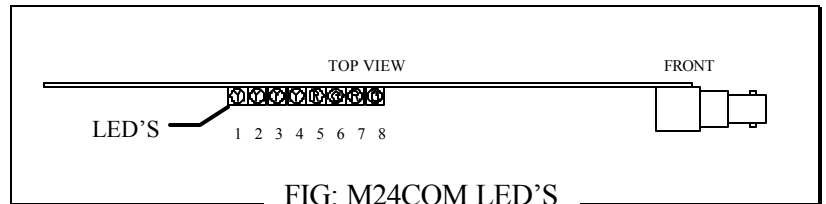

FIG: M24COM LED'S

L.E.D.	Colour	Function
D1	YELLOW	This three LED's code the M24COM scan status. They can be considered as the 'Or-Wired' status of the equivalent M24MX4 signals. Status: 5 - end of scan, 6 - scanning, 7 - ready to scan
D2	YELLOW	
D3	YELLOW	
D4	YELLOW	RUN light: Flashes when the CPU is running.
D5	RED	Encoder Reverse: Flashes when the encoder is rotating reverse
D6	GREEN	Encoder Forward: Flashes when the encoder is rotating forward
D7	RED	RECEIVE data from M24HST board over the M24C10 backplane
D8	GREEN	TRANSMIT data to M24HST board over the M24C10 backplane

**4.1.2.3 On Board Headers**

There are three headers labeled JP3, JP4 and JP5 located on the circuit board.

JP3 is a header designed to connect directly to the M24C10 cabinets COM1 RS-232 serial port cable / DB9 connector. This allows serial communication with the M24COM board directly for diagnostics, status and operation information.

JP4 is a header designed to connect directly to the M24C10 cabinets COM2 RS-485 serial port cable / DB9 connector. This allows serial communication with the M24COM board directly for diagnostics, status and operation information.

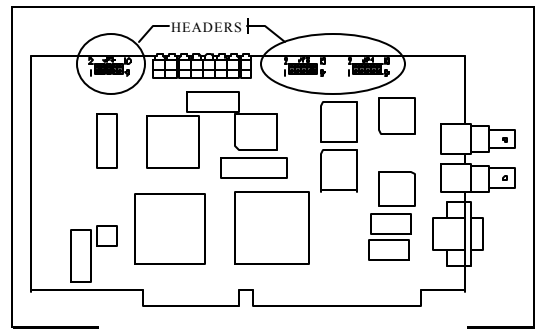

NOTE: the JP3 & JP4 cable is designed to mate with the COM1 & COM2 cables from Diversified Technologies 10 slot backplane. Other cabinet manufacturer may not comply.

Both JP5 and JP7 are for **factory testing only** and there setting should not be changed. JP5 must have a jumper on it at all times during operation, JP7 doesn't have any jumper set.

**4.1.2.4 Connecting the Encoder to the M24COM**

The pulse output from the rotary encoder is input to the M24COM board and then propagated to each of the M24MX4 boards over the M24C10 backplane. The rotary encoder is mechanically coupled to the scanner transfer mechanism (chain) to produce pulses in proportion to the chain travel.

The encoder connected to the M24COM board using a DB9 connector labelled P1 on the board. Refer to the diagram.

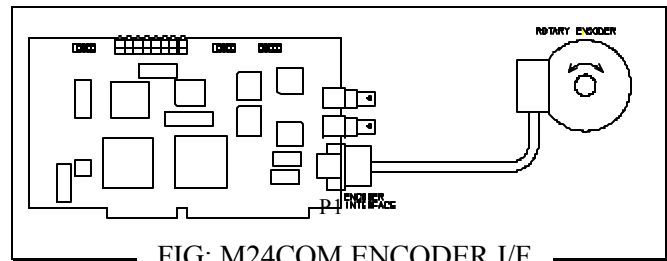

The pin out for the DB9 connector is :

PIN 1	Signal : A+
PIN 2	Signal : A-
PIN 3	Signal : B+
PIN 4	Signal : B-
PIN 5	POWER : +5 VDC
PINS 6 - 9	POWER : GND

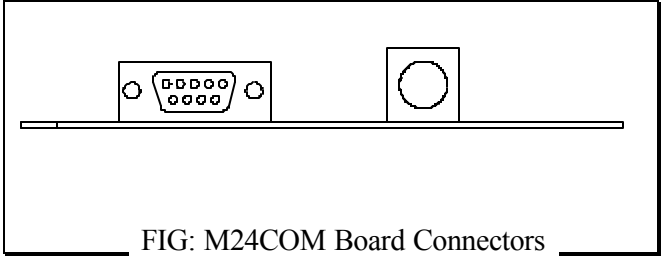

FIG: M24COM Board Connectors  
(Viewed toward connectors)

**4.1.2.5 Connecting the M24COM to the M24HST**

Standard fiber optic cable is used to connect the M24COM board back to M24HST board. There are two fiber optic cables, one for transmitting and one for receiving. The following diagram shows the cabling connections:

Fiber optic cable lengths can be up to 1000 feet. It is recommended that the fiber optic cables are run through conduit to provide physical protection. Take care to ensure that the cables do not get 'knicked' or 'kinked'.

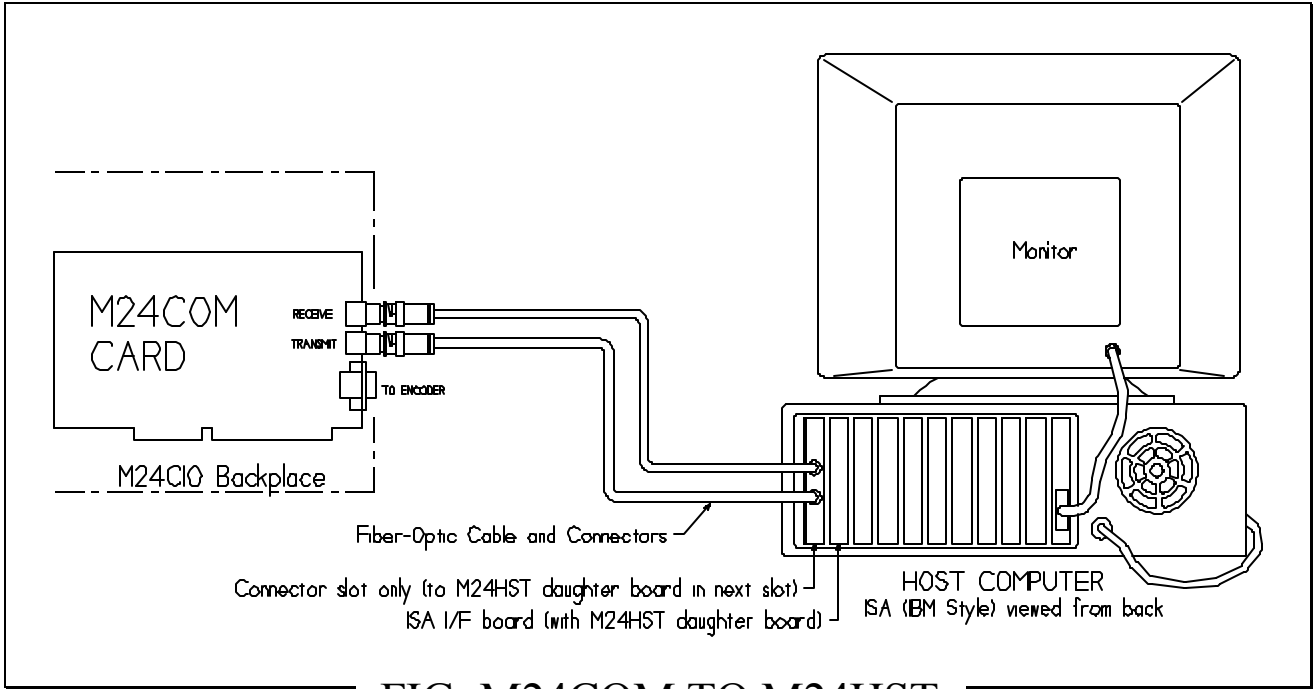
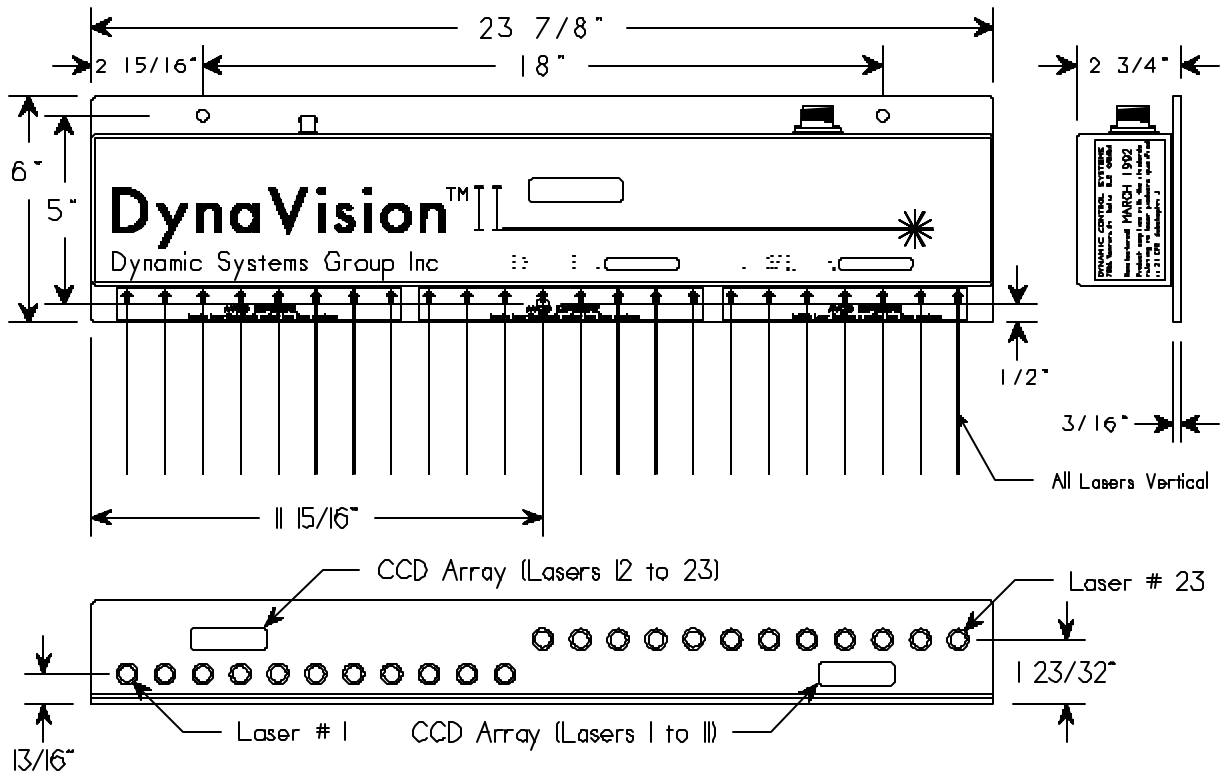

FIG: M24COM TO M24HST



## 4.2 M24 SENSOR HEADS

### 4.2.1 Cabling/Power

Power supplies to operate the heads should be mounted in a cabinet on or near the scanner frame to reduce voltage drops to each head. A single four wire cable is run to each head from the power supply. The power cable connector used is an MS 3106E-14S-6S connector. Voltages and pinouts are indicated in the drawing below:

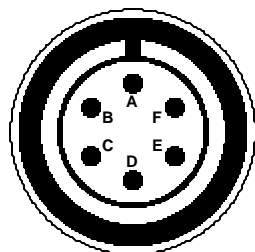

Pin	Signal
A	Rx+ RS485 Serial Communication
B	Rx- RS485 Serial Communication
C	+15 VDC @ 1.5 A
D	Ground
E	Tx+ RS485 Serial Communication
F	Tx- RS485 Serial Communication

Pin out of the power connector which attaches to the sensor head.

## **5. SCANNER SOFTWARE**

### **5.1 WHAT'S ON THE DISK?**

The following lists the files which are included in the 'root' directory of the OEM Software Release diskette and gives a brief description of it's purpose:

<b>M24LIB .H</b>	'C' header file containing the function prototypes for the 'M24-Series' library module.
<b>M24LIB .C</b>	Linkable library source code containing the 'M24-Series' functions.
<b>M24.EXE</b>	Program running under MS-DOS® to display a variety of scanner related data.
<b>FACTOR.DAT</b>	ASCII file to be read by M24.EXE containing scanner frame parameter.
<b>EGAVGA.BGI</b>	Graphical driver accessed by M24.EXE.

### **5.2 BIOS CONSIDERATIONS**

The system housing M24HST host card must be capable of setting the BIOS up to allow the Video RAM to be shadowed.

If possible, it is advised that the BIOS be configured to disable 'flushing' the cache memory when the A20 address line is activated. Our own experience with various CPU manufacturers has shown that when this option is enabled, problems can occur when attempting to address the M24HST card.

If using cached memory, it is necessary to ensure that the 64Kb memory segment starting at location 0xD000h is designated as non-cacheable area.

### 5.3 PROGRAMMING APPLICATION EXAMPLE - BOARD SCANNING

#### 5.3.1 Overview

This program will reside in the IBM-AT host processor and will assemble all the scan information from each head/spot and transfer this data to the target optimizer. The target optimizer could reside within the host processor, an AT co-processor board or a co-processor residing in another bus interfaced using a commercially available bus interface product. The M24-Series C interface library is supplied for the calls shown in the example. This program would either be executed as the main program or as a TSR.

#### 5.3.2 Pseudo Code

```
Scan_Process
  Periodically do
  begin
    if m24_getboardready () do          /* check if board data have been collected */
      begin                             /* copy all spot buffer data to destination optimizer */
        for each head do               /* for all the heads insatlled */
          for each spot do             /* for each of 23 spots in a head */
            /* transfer buffered data of the spot to destination buffer*/
            count = m24_getspotbuffer(head,spot,offset,size,&destination);
            clear_board_ready ();      /* Tell scanner buffer was read - reset board ready flag*/
            run_optimizer ();           /* Run optimizer if resident else tell co-processor to run */
          end;
        else
          begin
            do_whatever();
            do_any_diagnostics_required;
            do_any_other_utilities;
            read_write_files_etc;
          end;
        end;
      end;
    end.
  end.
```

### 5.4 DIAGNOSTICS

Dynamic Control Systems Inc. has supplied a standalone program running under MS-DOS® operating system which will display dynamic information from all the sensors installed. These programs can be used to confirm that the scanner is operating correctly before testing user programs or diagnostics.

Refer to section 5.1 “M24 Diagnostic Program - what’s on the disk?” for a description of the program and its functions.

Additional diagnostic programs can be written using the function calls in the M24-Series C library to implement real time displays of sensor data within the user application program.

## 5.5 CALIBRATION

Once all the sensors have been mounted in the scanner frame, two calibration calculations need to be performed. While the two calculations are described below separately, the recommended procedure for both calculations is the same and are often combined into one calibration sequence.

### 5.5.1 Laser Alignment Offset

The first of these calibration calculations compensates for the different laser placement as a result of the sensor's mounting and manufacturing variations of the frame. These alignment variations need to be taken into account in order to align the scanner model data later.

The calibration routine needs to determine the offset values in encoder pulses for all the lasers on the scanner frame referenced to a common 'zero' point and in the direction of travel, then save the results for later use. The recommended method to use to guarantee that the readings are taken from the same location is to run a straight edge calibration piece through the scanner and examine the scan buffers.

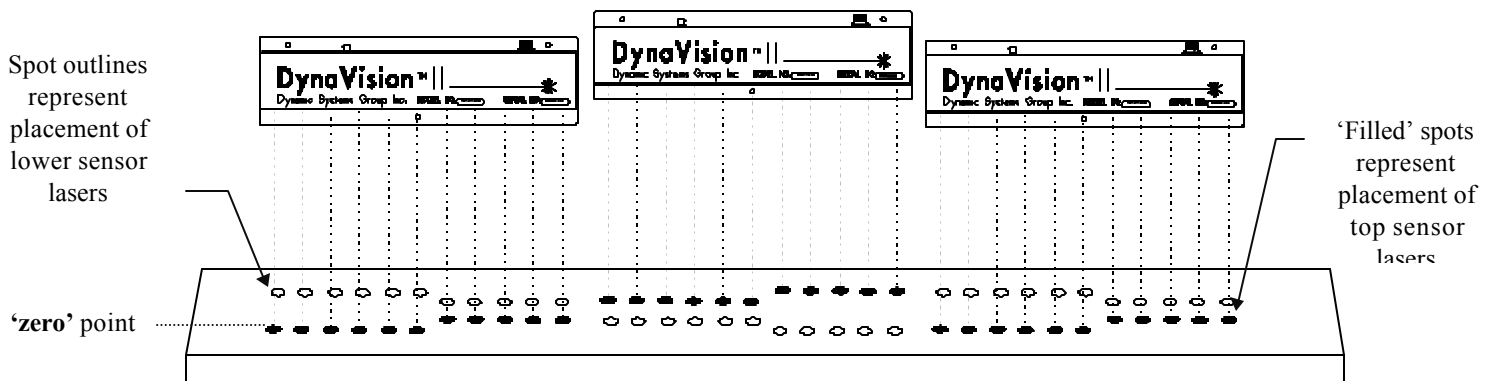

During the calibration process, an offset value of 0 is used when reading the spot buffers. The number of blank (out of range) entries in each of the buffers corresponds to the offset value for that buffer. It is crucial that during the calibration process, the piece being scanned is straight to ensure the model data for all the buffers are aligned.

During normal operation, optimizer application software applies this offset values while reading spot buffers to properly align board data at every 1" zone.

## 5.5.2 Range Offset

The other calibration calculation to perform addresses the variations in range above or below the item being scanned, it also determines how the top and bottom halves of the model data join together when the viewing area of opposing sensors overlap.

The recommended method for determining the range offset requires a few steps:

- a) Measure the distances of all the top mounted sensors to the top of the transfer chain, average the results to determine a 'preset' value.
- b) Repeat the process for all the sensors mounted below the transfer chain.
- c) Pass a calibration piece of a known thickness through the scanner.
- d) For top mounted sensors, read the spot buffers of each laser and calculate the average range reading for the entire width of the piece. Compare the average with the 'preset' value less the calibration pieces known thickness to determine the range offset necessary for that spot.
- d) Repeat the same process for each spot of lower mounted sensors except that the comparison is only between the 'preset' value and the range reading.

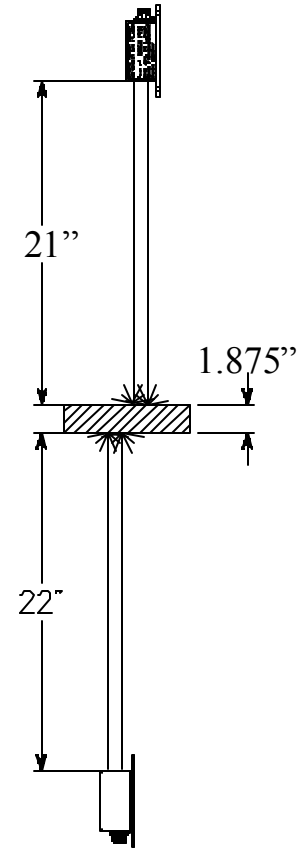

For example, referring to the diagram, if the average reading for a top sensor laser spot was 21.00" then the range offset for that laser spot would be calculated as:

$$\begin{array}{rclclcl} \text{Top 'preset'} & - & \text{Calibration Thickness} & - & \text{Average Spot Reading} & = & \text{Range Offset} \\ 23 & - & 1.875'' & - & 21.000'' & = & 0.125'' \end{array}$$

If the bottom sensor laser spot's average readings were 22 1/8", then it's offset would be:

$$\begin{array}{rclclcl} \text{Bottom} & - & \text{Average Spot Reading} & = & \text{Range Offset} \\ \text{'Preset'} & & & & & & \\ 22 & - & 22.125'' & = & -0.125'' \end{array}$$

## 5.6 M24-SERIES C LIBRARY

### 5.6.1 Overview

All access to the DynaVision hardware (M24 sensors, M24COM board etc.) is accomplished using the 'M24-Series' function calls in M24LIB.OBJ library module. The library is provided as a linkable module to allow a user scan process to retrieve spot buffers, diagnostic information and any other data that is required for optimization.

### 5.6.2 'C' Interface

The following macro definitions and function prototypes are declared in the M24LIB.H header file.:

```
#define DCS_SUCCESS          1      function compleated successfully
#define DCS_BAD_SEQ         -1     M24MX4 cards addressing out of sequence
#define DCS_TIMEOUT         -2     M24HST card communication timeout
#define DSC_NO_HOST         -3     M24HST card not present
#define DCS_BAD_ARG        -4     wrong function argument(s)

#define M24SCANS            2048   maximum size of a spot data buffer
#define M24HEADS            32     maximum number of M24 sensors installed in a system
#define M24SPOTS            23     number of lasers in one M24 sensor
```

---

**ROUTINE:** short far m\_getnumheads(void);

**PURPOSE:** Get number of heads installed

**INPUT:** void

**RETURN:** x # of heads installed in all MX4s  
 0 there are no M24 sensors attached  
 -1 MX4s are not in sequence  
 -2 timed out / no HOST--MX4COM communication  
 -3 host card is not present

**MODIFY:** N/A

## M-SERIES OEM DOCUMENTATION

---

**ROUTINE:** short far m\_getboardready (void);

**PURPOSE:** Check if board data are ready for use. The flag is set after the last laser in the whole system 'dropped' range readings, meaning that there is no target in the scanner.

**INPUT:** void

**RETURN:** 1 board buffer has been filled  
0 board buffer is not available  
-1 no heads are present-  
-2 timed out / no HOST--MX4COM communication

**MODIFY:** N/A

---

**ROUTINE:** short far m\_putboarddone (void);

**PURPOSE:** This call is used to clear board ready flag after all the buffers have been read.

**INPUT:** void

**RETURN:** 0 success  
-1 timed out / no HOST--MX4COM communication

**MODIFY:** N/A

---

**ROUTINE:** short far m\_getspotbuf (short head, short spot, short offset, short max\_scans, short far \*destination);

**PURPOSE:** Up to M24SCANS elements will be copied out of the internal scan buffer into the user scan buffer skipping the first 'offset' elements.

**INPUT:** short head : head index 0..31  
short spot : spot index 0..5  
short offset : offset within the internal scan buffer -2047..2047  
short max\_scans : user set limit on maximum number of scans to read 1..2047  
short far \*destination : pointer to users' data buffer to store samples

**RETURN:** n number of samples copied into destination buffer  
0 scanner either not started or given spot did not detected the target at all  
-1 invalid function argument

**MODIFY:** if return > 0 array passed by \*destination will be changed

**COMMENT:** Offset argument specifies index in the spot data buffer to start reading from. When targets' (board) leading edge is detected a global start index for sample buffers is set for all lasers in the system. At each encoder interrupt a range reading is stored for each laser in its corresponding sample buffer no matter if laser detects a target or not. Due to physical location of M24 sensor and its spots within the scanner system those lasers that already detect the target will store samples within the scope of the sensor and those yet to detect the target will store out of range samples values in its buffers, a unique value of 0x8000 hex. At the end when the target exits the scanner the board ready flag is set and buffer is ready for use. To properly align target data user needs to use unique offset value for each laser in the system acquired during calibration (see system calibration section of the manual).

**ROUTINE:** short far m\_getspotstatus (short head, short spot, short far \*destination);

**PURPOSE:** Read enable/disable status of a spot in given M24 head. The destination pointer has to point to a single short int memory location. Current range reading of this laser spot will be written into destination. If the spot is 'disabled' then the reading will be set to out of range value 0x8000hex.

**INPUT:** short head : head index  
short spot : spot index  
short far \*destination : memory address to store spots' range reading

**RETURN:** 1 OK, if spot is enabled, sets reading to current value  
0 spot disabled, sets reading to 0x8000  
-1 head # out of range [0..31] or spot # out of range [0..5] or head not installed

Range reading will by 0x8000 if the measurement is out of range .

**MODIFY:** if return = [0, 1] memory passed by \*reading will be modified

**ROUTINE:** short far m\_putspotstatus (short head, short spot, short enable);

**PURPOSE:** Enable or dissable a spot in given M24 head.

**INPUT:** short int head : head index [0..31]  
short int spot : spot index to dissable [0..5]  
short int enable : enable flag [0,1]

**RETURN:** 0 OK, spot n on head m dissabled  
-1 head # out [0..31] range or spot # out of [0..5] range or head not installed

A dissabled spot will return out of range readings (0x8000) if polled for data with m\_getspotbuf().

**MODIFY:** N/A

**ROUTINE:** short far m\_getspotdiag (short head, short far \*diag);

**PURPOSE:** Get an array of spot diagnostics from head n. There are diagnostics gof 6 spots returned only since this is an M6 library call.

\*diag[0] array contains range measurements in .001" units  
\*diag[1] array contains the sum of the CCD line camera pixel intensities  
\*diag[2] array contains number of CCD line camera pixels representing spots  
\*diag[3] array contains the spot sub\_pixel locations

**INPUT:** short head : head index  
short far \*diag : pointer to array to store the diagnostic data

**RETURN :** 0 OK  
-1 if head out of range / timeout

**MODIFY:** if return = 1 array passed by \*diag will be modified

## M-SERIES OEM DOCUMENTATION

---

---

**ROUTINE:** short far m\_reloadscanner (short head);

**PURPOSE:** This procedure is a NOP on M12 and M24

**INPUT:** void

**RETURN:** 0 = OK

**MODIFY:** N/A

---

**ROUTINE:** short far m24\_initscanner (short min\_wait, short min\_hold, short max\_scan,  
short min\_spots, short max\_rev\_count);

**PURPOSE:** Initialize gloval variables necessary for proper operation of the scanner system. This call must be the first call in an application, even when making M6 type calls.

**INPUT:** short min\_wait : # of enc. pulses to debouce leading edge [1..2047] -> 3  
short min\_hold : # of enc. pulses to debouce trailing edge [1..2047] -> 3  
short max\_scan : max. board width in encouder pulses [1..2047] -> 2047  
short min\_spots : min. number of spots to start a scan [1..23] -> 2  
short max\_rev\_counts : max number of reverse enc. couts to reset scan [1..2047] -> 500

**RETURN:** 1 OK  
0 all MX4s in order - but no head attached  
-1 MX4 addressing is not in sequence or doesn't start with 0  
-2 timed out / no HOST--MX4COM communications  
-3 host card is not present

**MODIFY:** N/A

**COMMENT:** indicates a default value

---

**ROUTINE:** short far m24\_getcards (short length, short far \*cards);

**PURPOSE:** Find out how many M24MX4 cards are installed in the system. An array passed by \*cards address will be initialized indicating presence of cards.

card[x] = 0 ... card is missing  
card[x] = 1 ... card installed

**INPUT:** short length : # of elements to copy  
short far \*cards : pointer to user card map

**RETURN:** n # of cards installed  
0 no cards are installed  
-1 MX4s are not in sequence  
-2 timed out / no HOST--MX4COM communication  
-3 host card is not present  
-4 length not within [1..8]

**MODIFY:** if return > 0 array array cards[] will be changed

**ROUTINE:** short far m24\_getspotbuf (short head, short spot, short offset, short max\_scans, short far \*destination);

**PURPOSE:** Up to M24SCANS elements will be copied out of the internal sample buffer into the user sample buffer skipping the first 'offset' elements.

**INPUT:**

short head	: head index	[0..31]
short spot	: spot index	[0..22]
short offset	: offset within the internal scan buffer	[-2047..2047]
short max_scans	: user set limit on maximum number of scans to read	[1..2047]
short far *destination	: pointer to users' data buffer to store samples]	

**RETURN:**

x	# of scans
0	head or spot out of range, or head not installed
-1	MX4s are not addressed in sequence
-2	time out - no M24HOST--M24COM communication

**MODIFY:** if return > 0 array passed by \*destination will be changed

**COMMENT:** Offset argument specifies index in the spot data buffer to start reading from. When targets' (board) leading edge is detected a global start index for sample buffers is set for all lasers in the system. At each encoder interrupt a range reading is stored for each laser in its corresponding sample buffer no matter if laser detects a target or not. Due to physical location of M24 sensor and its spots within the scanner system those lasers that already detect the target will store samples within the scope of the sensor and those yet to detect the target will store out of range samples values in its buffers, a unique value of 0x8000 hex. At the end when the target exits the scanner the board ready flag is set and buffer is ready for use. To properly align target data user needs to use unique offset value for each laser in the system acquired during calibration (see system calibration section of the manual).

---

**ROUTINE:** short far m24\_getspotstatus (short head, short spot, short far \*destination);

**PURPOSE:** Read enable/disable status of a spot in given M24 head. The destination pointer has to point to a single short int memory location. Current range reading of this laser spot will be written into destination. If the spot is 'disabled' then the reading will be set to OUT\_OF\_RANGE value 0x8000h.

**INPUT:**

short head	: head index
short spot	: spot index
short far *destination	: memory address to store spots' range reading

**RETURN:**

1	spot is enabled
0	spot is disabled
-1	MX4s addresses are not in sequence
-2	time out - no HOST--MX4COM communication
-3	M24HOST card not installed
-4	M24 head or spot index invalid, or M24 head is not installed

**MODIFY:** if return = 0,1 memory passed by \*destination will be modified

## M-SERIES OEM DOCUMENTATION

---

**ROUTINE:** short far m24\_putspotstatus (short head, short spot, short enable);

**PURPOSE:** Enable or dissable a spot in given M24 head.

**INPUT:** short head : head index  
short spot : spot index  
short enable : enable flag

**RETURN:** 1 OK  
-1 MX4s addresses are not in sequence  
-2 time out - no HOST--MX4COM communication  
-3 M24HOST card not installed  
-4 head or spot out of range, or head not installed

**MODIFY:** N/A

---

**ROUTINE:** short far m24\_getspotdiag (short head, short far \*diag);

**PURPOSE:** Read spot diagnostics from M24 head into the diagnostic array.

\*diag[0] array contains range measurements in .001" units  
\*diag[1] array contains the sum of the CCD line camera pixel intensities  
\*diag[2] array contains number of CCD line camera pixels representing laser spots  
\*diag[3] array contains laser spot sub\_pixel locations  
\*diag[4] array contains power values for each laser

**INPUT:** short head : number of head  
short far \*diag : pointer to array to store the diagnostic data

**RETURN:** 1 OK  
-1 MX4s addresses are not in sequence  
-2 time out - no M24HOST--M24COM communication  
-3 M24HOST card not installed  
-4 Head not installed or invalid head index ( out of range [0..M24HEADS-1] )

**MODIFY:** if return = 1 array passed by \*diag will be modified

**COMMENT:** Cast \*diag[1] as an unsigned short !!!

---

**ROUTINE:** short m24\_reset (void);

**PURPOSE:** Reset M24 Scanner. This procedure will cause a reset and reload of all software and power variables for the M24COM and M24MX4 boards. It will take approximately 3 seconds to execute

**INPUT:** void

**RETURN:** 1 OK  
0 time out - no M24HOST--M24COM communication

**MODIFY:** N/A

## **5.7 M24 DIAGNOSTIC PROGRAM**

### **5.7.1 Overview**

Dynamic Control Systems Inc. has supplied a standalone program running under MS-DOS® operating system which will display dynamic information from the scanner system itself and from all the M24 sensors installed. These programs can be used to confirm that the scanner is operating correctly before testing user programs or diagnostics.

To start the program type `c:\>M24 <ENTER>`

### **5.7.2 System Screen**

The first display shows the status of the entire scanner system. The shadowed box at the left hand side represents the M24HST board sitting in the host computer. The box at the right hand side shows the M24C10 systems enclosure containing the M24COM card and eight M24MX4 cards. Cards installed will have a gray colour otherwise they are displayed red. M24 sensor heads connected to the M24MX4 cards are indicated by their logical number. Are the M24HST and M24COM cards communicating with each other a green bar will be flashing. The example below shows that only the M24MX4 card addressed '0' is installed and only one M24 sensor head is connected.

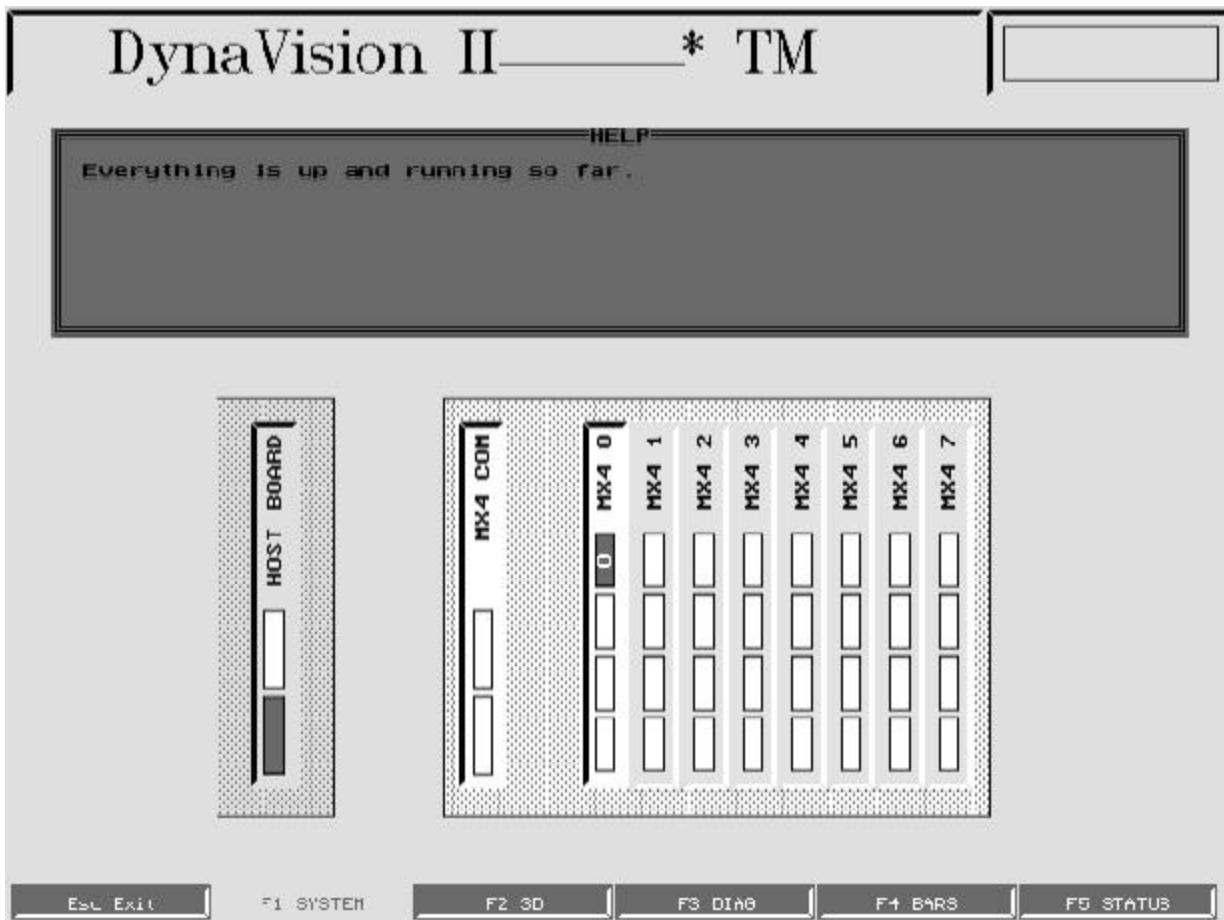

### 5.7.3 3D Profile Screen

This screen will show board profiles based on the raw data delivered by the scanner. In order to use this screen properly it is necessary to edit the FACTOR.DAT file which will be accessed by the M24 program. Important are the 'Top head to top of chain' and 'Bottom head to top of chain' parameters. These are the actual distances measured at the scanner frame in thousand of an inch. Should nothing appear on the screen although boards are running through the scanner these parameters should be checked again. Are these parameters correct and there is still nothing displayed or the data are strange looking check all the components starting with the M24 sensor heads using the following displays.

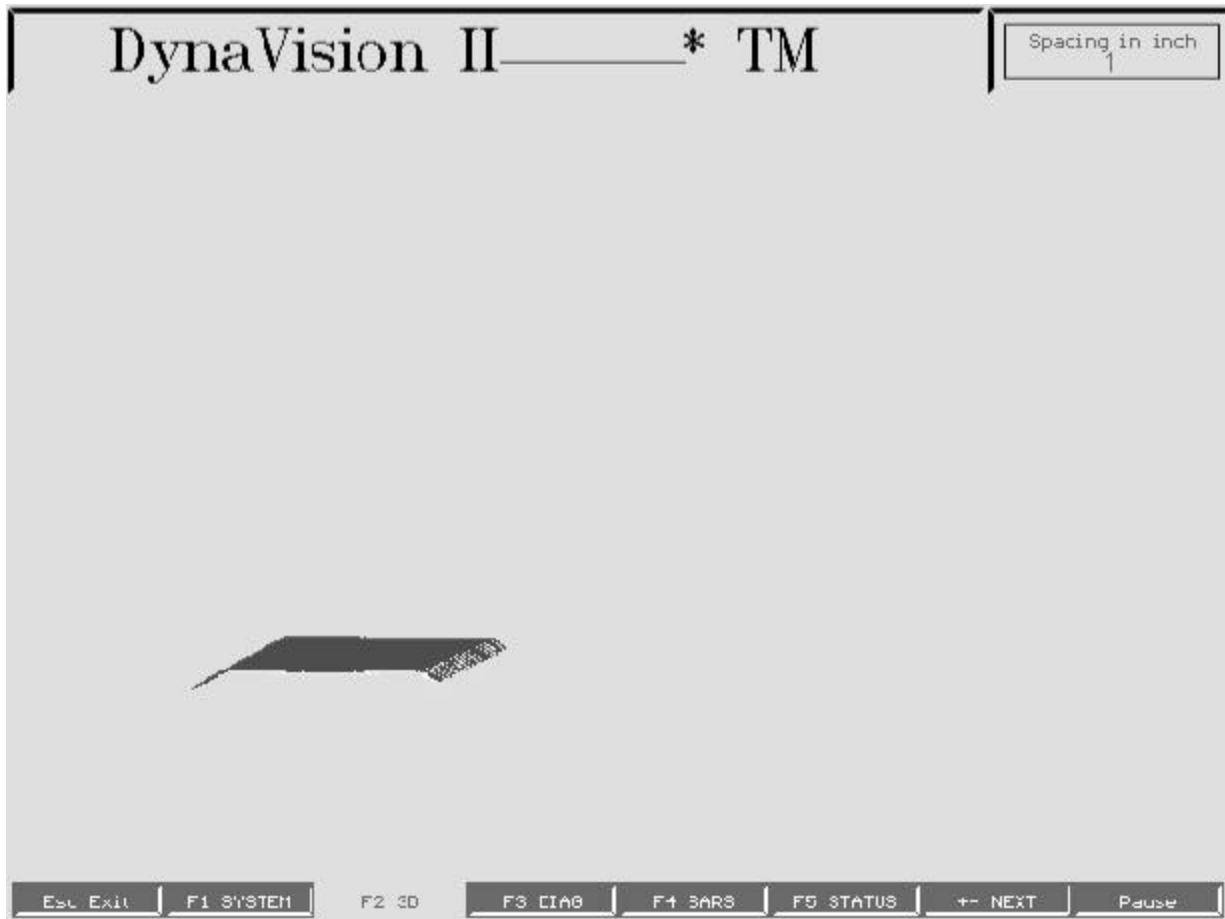

**5.7.4 Diagnostic Screen**

This display shows diagnostic data for each spot and each M24 sensor head. Switch from head to head by using the '+' and '-' keys. The figure below shows data from head '0' targeting a board. For M24 sensor heads which are not installed the value displayed will be error code '-4' (DCS\_BAD\_ARG).

Installing a scanner it is important that the baffle plates are properly aligned. If there is no target in the scanner each spot of all the M24 sensor heads should show OUT\_OF\_RANGE (8000h), the subpix values should be zero, width and sum are not cleared and show the last readings and the power values would show a 100. Non of the numbers should be flickering or change at all. If this is the case the spot is hitting for instance the opposite baffle plate or a very bright light source is close to the scanner.

DynaVision II * TM					Head Nr. 0
Spot	RANGES	SUBPIX	SUM	WIDTH	POLER
Spot 0	7.323	22296	780	11	43
Spot 1	7.271	24378	377	13	41
Spot 2	7.276	26551	352	9	27
Spot 3	7.270	28839	310	12	25
Spot 4	7.259	31258	579	11	34
Spot 5	7.279	33790	712	11	21
Spot 6	7.264	36375	715	11	35
Spot 7	7.257	39070	730	11	27
Spot 8	7.251	41970	829	12	15
Spot 9	7.267	44952	744	11	13
Spot 10	7.250	48040	728	10	17
Spot 11	7.256	14570	327	12	12
Spot 12	7.257	17835	315	13	14
Spot 13	7.252	20988	312	13	13
Spot 14	7.249	24016	321	11	14
Spot 15	7.234	26952	729	12	14
Spot 16	7.233	29789	300	12	27
Spot 17	7.227	32441	306	12	24
Spot 18	7.222	34997	341	12	44
Spot 19	7.219	37541	797	11	32
Spot 20	7.217	39899	327	12	22
Spot 21	7.212	42167	768	10	23
Spot 22	7.205	44402	717	10	54

Esc Exit | F1 SYSTEM | F2 ED | F3 DIAG | F4 BARS | F5 STATUS | +- NEXT | Pause

**5.7.5 Bar Graph Screen**

This screen shows the range data for each M24 sensor head displayed as bar graphs.

### **5.7.6 Status Screen**

The 'Status Screen' shows several on-line parameters for each M24MX4 card installed such as:

- Heads inst:** Indicates how many M24 sensor heads are connected to the M24MX4 card. (up to 4)
- Heads valid:** For each M24 sensor head connected to the M24MX4 a '1' will be set otherwise a '0'. The example below shows that only head 0 is connected to the M24MX4 card addressed 0.
- Spots seen:** The sum of all spots of all sensor heads connected to the M24MX4 card. (maximum  $4*23=92$ )
- Scan state:** Status of the scanning process as follows:
- 5 - end of scan (the object to scan just passed by)
  - 6 - scanning (the object is in the scanner)
  - 7 - ready to scan (there is no object in the scanner)
- Fwd count:** Forward encoder count. If the scanner is in status 7 and the encoder is turning the count will increase constantly. Scan status 5 will reset the counter to zero. If the encoder turned backwards more than *max\_rev\_count* encoder pulses the forward encoder count will be reset to zero with the first following forward encoder pulse.
- Rev count:** Reverse encoder count. With the first forward encoder pulse the reverse encoder count will be reset to zero if the encoder was turned backwards more than *max\_rev\_count* otherwise the reverse count decreases down to zero as the encoder gets turned forward.
- Cur buffer:** Current scan buffer. The scan data are stored in two alternating buffers. The number will toggle between '0' and '4'.
- Cur index:** Index into the currently used scan buffer. This index starts at 2048 and wraps around at 4096.
- Cur rel idx:** Current relative index. During the time an object is in the scanner this index counts encoder pulses. It gets reset to zero in scan state 5 and starts to count if an object enters the scanner.
- Prev size :** Previous size. Width of the object scanned
- Prev index:** Previous index. Index into the scan buffer previously used to the begin of the scan data.

## M-SERIES OEM DOCUMENTATION

---

- Wait count:** Minimum wait count. Starts to count encoder pulses if an object enters the scanner and more then *min\_spots* lasers hit the object. Does this counter exceeds *min\_wait* (initialized by **m24\_initscanner(..)**) the scan status changes from '7' to '6'.
- Hold count:** Minimum hold count. Starts to count encoder pulses if an object leaves the scanner and less then *min\_spots* lasers hit the object. Does this counter exceeds *min\_hold* (initialized by **m24\_initscanner(..)**) the scan status changes from '6' to '5'.
- Ready flag:** Flag set if a object passed the scanner and the data are ready for access. This flag is used by the function **m\_getboardready()**.
- Flag reset:** Counter to count how often the ready flag was set. This counter should be synchrony with the number of objects scanned. After the ready flag is set it will be cleared immediatly and the the counter will increase by one. The ready flag is cleared automatically only using this display.

The color bars in each row indicates the scan status of each M24MX4 card. The leftmost bar is the scan status of the entire system. The scan status is color coded as follows:

5 - red

6 - yellow

7 - green

DynaVision II * TM							
	HX+ 0	HX+ 1	HX+ 2	HX+ 3	HX+ 4	HX+ 5	HX+ 6
Heads inst	1	-4	-4	-4	-4	-4	-4
Heads valid	1000	-4	-4	-4	-4	-4	-4
Spots seen	23	-4	-4	-4	-4	-4	-4
Scan state	6	-4	-4	-4	-4	-4	-4
Fud count	2787	-4	-4	-4	-4	-4	-4
Rev count	0	-4	-4	-4	-4	-4	-4
Cur buffer	0	-4	-4	-4	-4	-4	-4
Cur index	2787	-4	-4	-4	-4	-4	-4
Cur rel idx	100	-4	-4	-4	-4	-4	-4
Prev size	392	-4	-4	-4	-4	-4	-4
Prev index	2769	-4	-4	-4	-4	-4	-4
Wait count	6	-4	-4	-4	-4	-4	-4
Hold count	0	-4	-4	-4	-4	-4	-4

--	--	--	--	--	--	--	--

	COF
Ready flag	0
Flag reset	1

Esc Exit	F5 STATUS	F6 TIMING	F7 HX+	F8 COM	Pause
----------	-----------	-----------	--------	--------	-------

## 5.7.7 Timing Screen

This screen displays data transfer rates for each M24 sensor head. There are two transfer rates, one for transferring the data into the M24HST fifo and one for reading the data out of the fifo into the host computer memory.



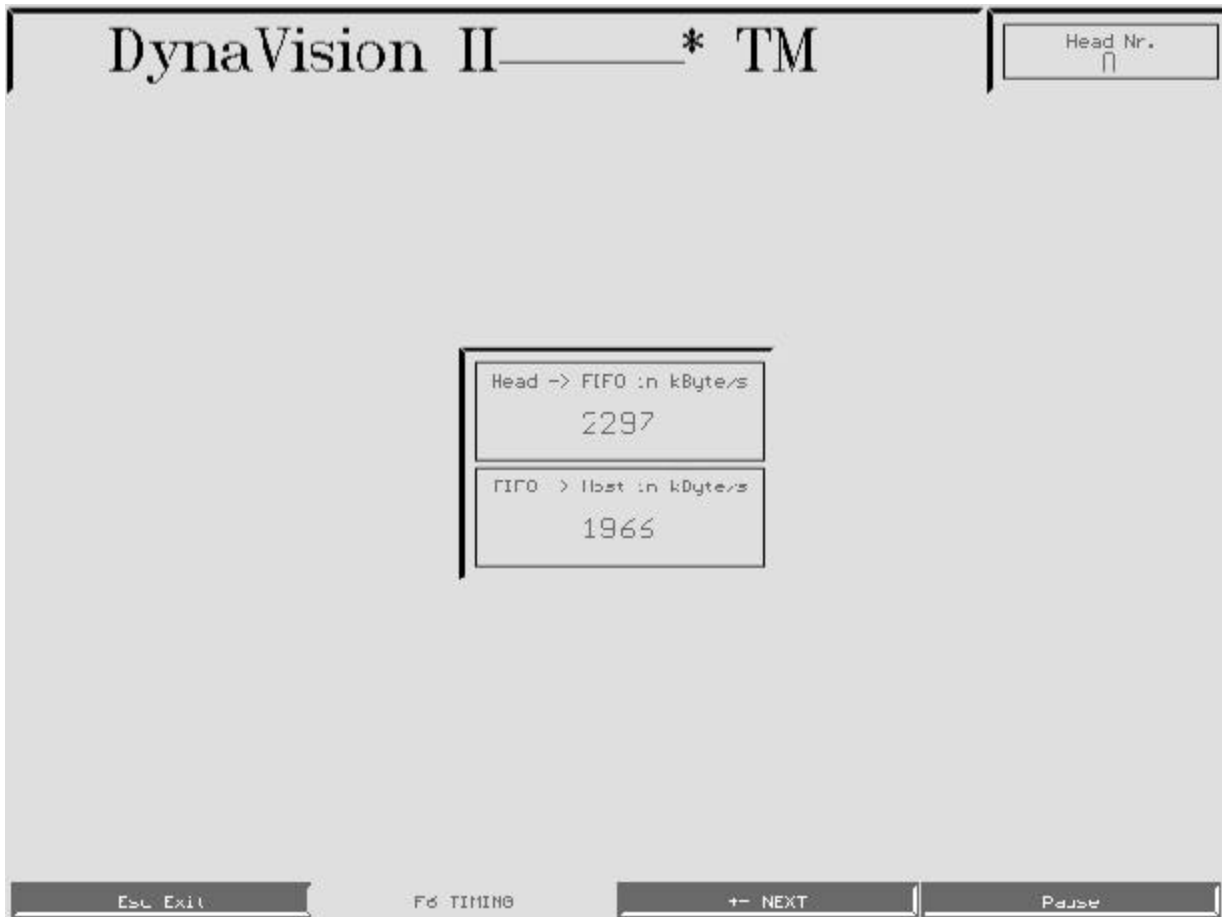

### **6. OPTIMIZATION IMPLEMENTATION**

The optimization procedures using the profile information are performed in the host computer. The DynaVision™ M24 scanner can be interfaced to many hardware platforms (ISA bus, VME, VAX, etc.) through the industry standard I-PAC interface. The I-PAC is supported by several 3rd party vendors for different platforms. The M24HST board is designed to plug into the Greensprings I-PAC board.

The optimization can take place within the host environment using the resident processor or a co-processor.

#### **6.1 RESIDENT OPTIMIZER ('386/'486/PENTIUM CPU)**

A resident implementation of the optimization would require use of the highest performance processor available. This assumes that the optimization procedure requires a large amount of CPU time and therefore will slow performance of any operator interface running under MS-DOS®. Careful attention must be paid to data transfer times and execution times.

#### **6.2 RESIDENT CO-PROCESSOR OPTIMIZER**

The resident co-processor should be selected with a memory mapped window that does not overlap memory from 0A0000h to 0DFFFFh which is used by the Video and DynaVision™ controllers. Preferably the window should have a configurable size, location and the ability to be disabled under program control. The speed of this processor need only be dependent on the speed of optimization required and any communication requirements for solution output. The co-processor would receive the spot buffer data via a clock or interrupt driven TSR which calls the C library procedures to transfer spot buffers to the target co-processor window.

##### **6.2.1 Non-Intel based systems**

When transferring data from one system to the next it is important to remember that the method of storing data in memory differs in the Intel processors from the method employed by Motorola and other manufacturers. As a result, it may be necessary to swap the MSB and LSB 16 bit segments of data before, or after transferring the data streams from one machine to the next.

### 7. SCANNER FRAME DESIGN

#### 7.1 OVERVIEW

A general scanner frame design with dimensions is included for a guide to the critical dimensions. This is the basis for a frame design and it is recommended that the user individualize the design to match existing user equipment. Some points to consider are:

- Mount the sensor heads on the downstream side of the scanner frame so that debris travels away from the sensor heads.
- Sensor heads should be mounted on standoffs with a 2 1/4" difference between heads side to side and top to bottom. This prevents the lasers from adjacent sensors from being mistaken for laser spots within a valid sensor range.
- The heads on the bottom have the lasers mounted in the opposite direction. Therefore spot 1 on top head is in the same plane with spot 23 on the bottom head.
- The baffle plate design included is for the exact top to bottom head spacing shown on the frame. If different spacing is desired then the center holes must be moved to allow for the angled beams from the opposite head. There are four different baffle plates with two for top heads (different standoffs) and two for bottom heads.
- The frame shown uses 6"x12" tube stock as the support beam. This may not be rigid enough over long spans. Therefore your own structural personnel should use this as a guide for the frame and not the final frame design.
- Cabling for the heads is run inside the frame support beam to one end of the frame where power supplies and conduits to computer room are located.
- Each head is mounted at three points on standoffs to prevent distortion. Generally we have put studs in the frame for the connector side of the head to make it easier to mount the head in the field (head is heavy). The laser side of the head should use a cap head socket screw that is below the window (out of the field of view) when tightened.
- Heads are generally mounted with the first laser line 1" or 2" inside the 'zero lumber line' and continuing with a laser every four inches the length of the frame. The bottom heads are usually aligned with the top heads. However, other variations are possible.

For example, the top and bottom sensor heads could be offset by 2" to increase length resolution. Since the lasers for the opposing sensor are not directly opposite one another, this technique will affect the exact thickness measurement returned, but it is not likely that it will affect the optimizer solution.

- On edger and cant optimizer where pins are used to skew and offset the piece, the skew pins should be aligned as close as possible to a laser spot to guarantee skew and offset position.
- A positive air pressure blower/purge system should be designed into the frame for clearing the bottom heads. We have found on several installations that if the bottom heads are cleaned every 2 to 4 hours without air purge the systems run fine. However performance can be degraded if heads are running dirty and therefore an air purge is recommended. When installing an air purge using mill air, make sure to filter the air to remove oil and water.

### **7.2 CHAIN SPACING**

#### **7.2.1 New Mechanical**

Try to mount the chains between the heads (2 foot centers) with chainways as narrow as possible. The ideal is have no laser beams hitting any chain ways. This may be achieved by eliminating the side rails at the point that the laser would strike it and let the chain only travel on the bottom center guide.

#### **7.2.2 Retro-Fit Mechanical**

If possible mount the frame with chains between heads or with as few bottom laser spots disturbed.

### **7.3 FRAME DRAWINGS**

The following drawings are included:

- 1) Drawing Ref. #: FRMMECH - DynaVision Scanner Frame
- 2) Drawing Ref. #: FRMWCHN - DynaVision Scanner Frame
- 3) Drawing Ref. #: BFLUPR - Upper Frame Baffles
- 4) Drawing Ref. #: BFLLWR - Lower Frame Baffle





For use with 2.500" standoffs

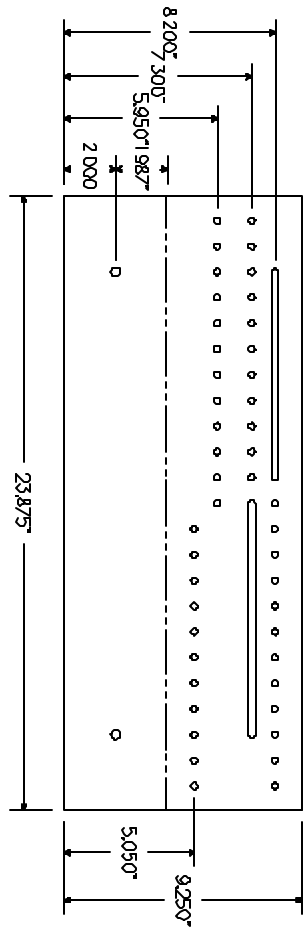

For use with 0.250" standoffs

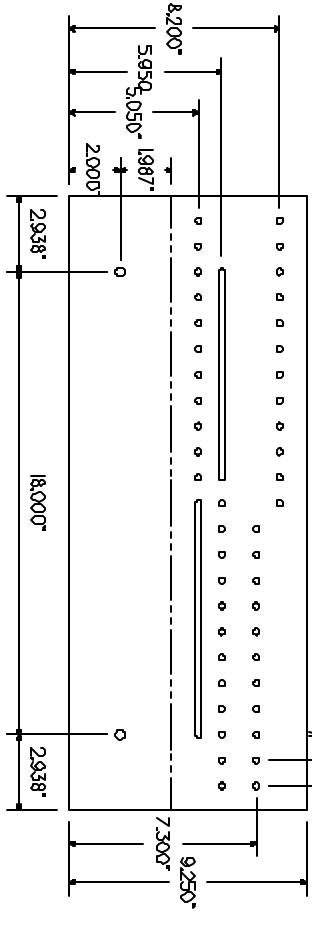

NOTES:

- Dashed line shows front of frame
- Break all sharp edges
- All holes and slots are 1/4" diameter
- This drawing is only to be used as a reference for the making of M24 baffle plates

REVISIONS.

INITIAL	DATE
DRIVING BY: GQ	13DEC95
CHECKED BY: BD	
APPROVED BY:	

THIS DOCUMENT SUBMITTED IN COMPLIANCE WITH THE REQUIREMENTS OF THE NATIONAL ARCHIVES AND RECORDS ADMINISTRATION. IT IS THE PROPERTY OF DYNAMIC CONTROL SYSTEMS. IT IS TO BE USED ONLY FOR THE PURPOSES AND IN THE MANNER SPECIFIED HEREIN. IT IS NOT TO BE REPRODUCED OR TRANSMITTED IN ANY FORM OR BY ANY MEANS, ELECTRONIC OR MECHANICAL, INCLUDING PHOTOCOPYING, RECORDING, OR BY ANY INFORMATION STORAGE AND RETRIEVAL SYSTEM, WITHOUT PERMISSION OF DYNAMIC CONTROL SYSTEMS.

M24 FRAME Baffles		DYNAMIC CONTROL SYSTEMS		ASTA, INC. OMAHA	
SCALE: 1:1	SIZE: A	DRAWING REF: BFLUPR	REVISION: -	SHEET: 1 OF 1	

For use with 2.500" standoffs

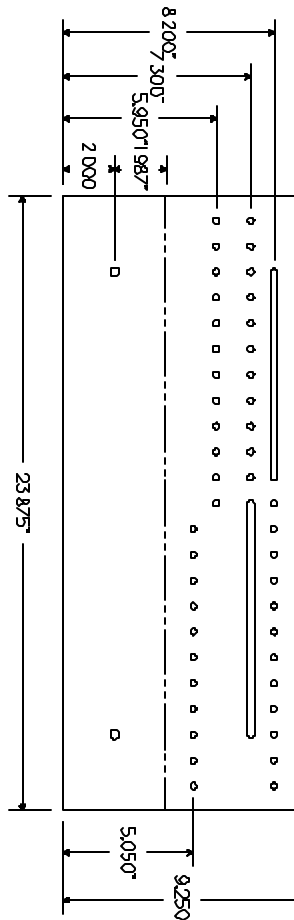

For use with 0.250" standoffs

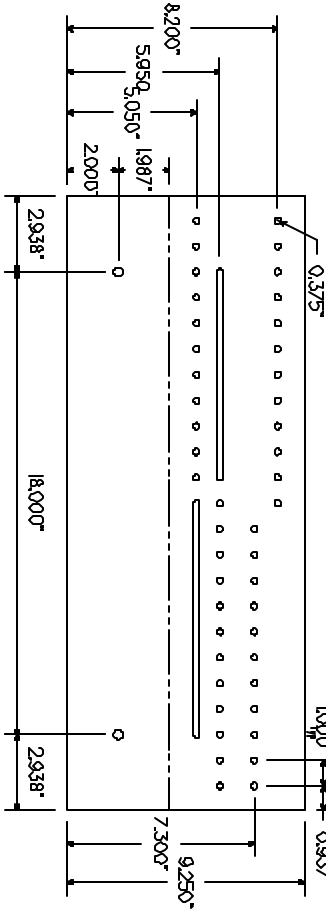

NOTES:

- Dashed line shows front of frame
- Break all sharp edges
- All holes and slots are 1/4" diameter
- This drawing is only to be used as a reference for the making of M24 baffle plates

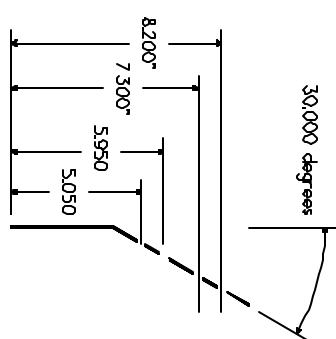

INITIAL	DATE
DRAWING BY:	13DEC95
CHECKED BY: BD	
APPROVED BY:	

THE INFORMATION CONTAINED IN THIS DRAWING IS THE PROPERTY OF DYNAMIC CONTROL SYSTEMS INC. IT IS TO BE USED ONLY FOR THE PURPOSES AND IN THE MANNER SPECIFIED HEREIN. ANY OTHER USE WITHOUT THE WRITTEN PERMISSION OF DYNAMIC CONTROL SYSTEMS INC. IS PROHIBITED.

DYNAMIC CONTROL SYSTEMS		PART A, B/C	
		S/10/000	
M24 FRAME BAFFLES			
SCALE: 1:1	SIZE: A	DRAWING REF: BFLWR	REVISION: -
SHEET 1 OF 1			

### **8. SCANNER INSTALLATION**

The procedure describes the step by step instructions to install the DynaVision™ M24 scanner system.

#### **8.1 FRAME CONSIDERATIONS**

- To isolate the scanner from mill vibration, the frame should be mounted on an independent sub-base to the mill foundation. Shock mounts should be used to mount the scanner frame to the sub-base.
- The frame height should ensure the level of the transfer chain is correct according to drawings.
- The first scan head is located inside the even ending zero lumber line. This will locate the first laser scanning line 1"-2" in from the end of the lumber.
- Scan heads are numbered from the zero lumber line.
  - 0' top head, 2' top head ... N' top head
  - 0' bottom head, 2' bottom head ... N' bottom head etc.

#### **8.2 POWER SUPPLY CABINET CONSIDERATIONS**

- Mount the power supply cabinet on one end of the scan frame to allow proper access from the mill floor for installation and service.
- Position the cabinet on the end of the frame so there is proper clearance from the bottom access plate on the frame into the power supply cabinet to run the power cables.
- Ensure that any warning bulbs mounted on the scanner frame or power supply cabinet are not positioned where they are in direct view of any of the sensor heads cameras.

#### **8.3 INSTALL POWER CABLING**

- Fish the power supply cabling through the hole in the scanner frame (adjacent to each scan head), and out of the access cutout up into the power supply cabinet.
- There is one power cable per scan head.
- Label each power cable as 0' Top, 0' Bottom, etc. so that you know where to wire them in the cabinet. Any excess cable length should be inside the frame tubing.

## 8.3.1 Identify the Power Cable Wiring

- Use Belden 9773 cable.
- Each power cable has 3 pairs of wires:

Pair #1:	Red	->	+15 VDC
	Black	->	Gnd
Pair #2:	Green	->	Rx+ (RS 485 serial communications)
	Black	->	Rx- (RS 485 serial communications)
Pair #3:	White	->	Tx+ (RS 485 serial communications)
	Black	->	Tx- (RS 485 serial communications)

## 8.3.2 Identify the Terminal Blocks

- There are two groups of terminal blocks in the power supply cabinet. The top group is for the top heads and bottom group is for the bottom heads.
- Each terminal block group has three rows of terminals:

Top Row	-> +15v	(red wire (pair 1) power supply)
Bottom Row	-> GND	(black wire (pair 1) power supply)

## 8.3.3 Connect the DC Power Wiring

- Wire the scanner head power cables to the terminal strips in the power supply cabinet.
- Tops heads on wired on the top terminals strips with the 0' head on the left.
- Bottom heads are wired on the bottom terminal strips with 0' head on the left directly under the top head wiring.
- Ensure enough slack left in head end of cable to attach to scan head properly.

## 8.3.4 Connecting AC Power

- The cabinet is powered from a 120 VAC single phase power source. Note that where applicable a 240 VAC 50Hz or 60 Hz can be substituted to match local power; all references in this manual will be for 120 VAC.

**Note!**

AC power should be wired up to the computer room where the computer cabinet is so that both and the scanner frame junction box and the computer cabinet power are supplied by the same UPS (uninterruptible power supply).

- Ensure there is no power applied to the AC power cable to the scanner frame cabinet.
- Wire the AC power cable to the terminal strip on the lower left side of cabinet directly under power bar.

**Warning!**

Do not apply AC power for first time unless all DC power cables are disconnected from the scan heads.

- Apply 120 VAC power to the power cable. After a moment, the on delay timer will go on and power is supplied to the DC power supplies. Check the +15 VDC to DC-Gnd power level at the top and bottom terminal strips.
- With 120 VAC power applied to the cabinet, check each power connector at each scan head for correct power as follows

Pin C to Pin D = +15 VDC

- If any of the voltages are not correct for polarity or are not present, check the wiring at the power supply cabinet.
- Turn off the AC power to the scan frame.

### 8.4 INSTALLING SCAN HEADS

- The scan heads are held in place at three points (mounting holes).
- Two of the points (connector side) are mounted onto studs to allow the easy installation of shims to aim the scan head in case the frame is not aligned correctly. The other point is mounted with a hex cap screw.
- The studs should be installed in the frame with loctite and left to set to ensure studs are tight.
- Install all the baffle plates but do not tighten the mounting bolts yet (hand tight only so the plate sits flat on the scan frame. The flat baffle plates are located on the top and angled baffle plates on the bottom.
- There are two types of plates for the top. Ensure that the rows of holes for the laser beams match the rows of lasers from each head.
- With the AC power OFF to the scanner frame cabinet, plug the DC power cable each scan head. Ensure that the cables are fully pushed into place and the hold down sleeve screwed on hand tight.
- Turn on the AC power to the scanner frame cabinet. After a delay the DC power will be supplied to the scan heads.
- Observe the LCD display on the scan heads. Each scan head will cycle through and display a checklist of external and internal DCV values. The final display shows a bar graph of the range for each laser spot. The further away the object is detected the longer the bar. If there is not display for any of the heads check the power connection to that head. Next time the power is turned off then on observe the voltage values displayed on that head specific head for any indication of low voltage. If the voltage or the current is low (< 1.5A) to any of the heads then it will not function properly and appear that it is not working. If low current is suspected then check that the power supply has sufficient capacity to supply the complete frame (# of heads x 1.5 Amps) or check that the current limit adjustment for the power supply is set correctly.

#### **Warning!**

Ensure the power is off when installing or removing a power cable from a scan head.

- Using an infra-red viewing card or infra-red viewer check that the lasers from the top heads pass through the holes in the bottom head baffle plate. Adjust the baffle plate position and tighten the mounting bolts.

## M-SERIES OEM DOCUMENTATION

---

- The LCD display is also useful as a final check for aligning the baffle plates. After aligning with the viewer or card LCD display should show that no spots are being detected. A spot being detected would appear as a longer line on one or more of the bars on the graph. If one or more lasers are being detected then check that the baffle plate is aligned or the specific hole is blocked or misaligned.
- Check that the lasers from the bottom heads pass through the holes in the top head baffle plate. Adjust the baffle plate position and tighten the mounting bolts.
- If any of the lasers are detected on a chain or support structure then make note of which laser and which head this is occurring on. Software is used to disable the spot detection using the 'm24\_putspotstatus' command (see section 5). The beam could also be physically blocked but using software to disable the spot is the recommended method.

### 8.5 INSTALL COMPUTER CABINET

- The cabinet should be located close to the PLC cabinet.
- Wire AC power the lower left terminal strip below the power bar.

**Note:** Both the scanner frame junction box and the computer cabinet power should be supplied by the same UPS (uninterruptible power supply).

### 8.6 INSTALLING TWIN-AXIAL CABLES

- One twin-axial cable is required for each M24 sensor head installed on the system
- Prior to fishing the cables through the frame they should be labeled to identify them as 0' top head etc.
- If the scanner controller is mounted away from the scanner frame the bundle of twin-axial cables should be run in separate conduit / trays from the scanner frame to the computer room well away from all other AC and DC power cables. The cables enter the computer cabinet from the bottom right hand side through a conduit to be connected to respective BNC connectors mounted on M24MX4 cards.
- When inserting the twin-axial cable into the BNC connector, ensure that both signal wires mate straight with correct pins of the M24MX4 card BNC connector. Once the wires are mated and the twin-axial shield is inside the BNC jacket, twist the BNC connector onto the cable to hold it into place. Gently pull on the twin-axial cable and BNC connector to ensure that the cable is secure.
- Each M24MX4 card accepts up to four (4) twin-axial cables. M24MX4 card addressed as card 0 (see the blue rotary address selector mounted on the card) will interface M24 sensor heads indexed 0, 1, 2 and 3 (see section 4.2.2.5).

### 8.7 INSTALLING THE ENCODER

- The encoder should be installed on the scanner transfer chain.
- The encoder is wired to the computer cabinet with a shielded cable in separate conduit from the encoder to the computer room well away from all other AC and DC power cables. The cable enters the computer cabinet from the bottom right hand side through a conduit to be connected to M24COM card using a DB9 connector (see section 4.2.3).

### 8.8 M24 SENSOR HEAD CHECKOUT

- Ensure that 120 VAC power is ON to both the computer and scanning equipment.

#### 8.8.1 Setting Up Baffle Plates

- Execute M24.EXE and select the 'Diagnostic Screen' display. Refer to section 5.7.4 "diagnostic screen".
- This diagnostic screen continuously displays range readings of each laser on a selected M24 sensor head. If there is no board in the scanner all the range readings should be OUT\_OF\_RANGE ( 8000h). The *subpix* readings should show zeros. *Power* should be 100. *Sum* and *width* will show obsolete readings not cleared from the previous object scanned.
- If any spots are visible they **must be hidden** from the cameras view by adjusting of baffle plate (may involve filing or drilling) oposite the laser beam in question.

- Repeat until all laser spots are not visible.

### 8.8.2 Checking Scanner Readings

- Place a piece of wood in the scanner so that all beams will be visible top and bottom.
- Execute M24.EXE and select the 'Diagnostic Screen' display. Refer to section 5.7.4 "diagnostic screen".
- This diagnostic screen continuously displays readings of each laser on a selected M24 sensor head. If there is no board in the scanner all the range readings should have value of OUT\_OF\_RANGE (8000h).

### 8.9 ENCODER CHECKOUT

- Execute M24.EXE and select the 'Status Screen'. Refer to section 5.7.6. "status screenstatus screen"
- Run the encoder forward either by hand or by turning the scanner transfer chain.
- The 'Fwd count' should increment or the 'Rev count' should decrement depending on the direction of encoder movement.
- If the reverse counter increments then check the wiring in the DB9 connector.
- If the reverse counter continues to increment regardless of the wiring orientation, then inspect the encoder cable for damage. This occurrence is typically related to 'electrical noise'.
- Check the CH0DN and CH0UP LED's on the M24COM card in the computer cabinet. If the transfer line is moving, one or the other should be illuminated, but not both. They should indicate a forward and reverse movement of the scanner transfer respectively (see section 4.2.3.2).



